

D5

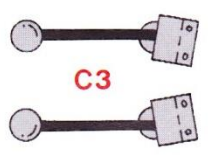

C3

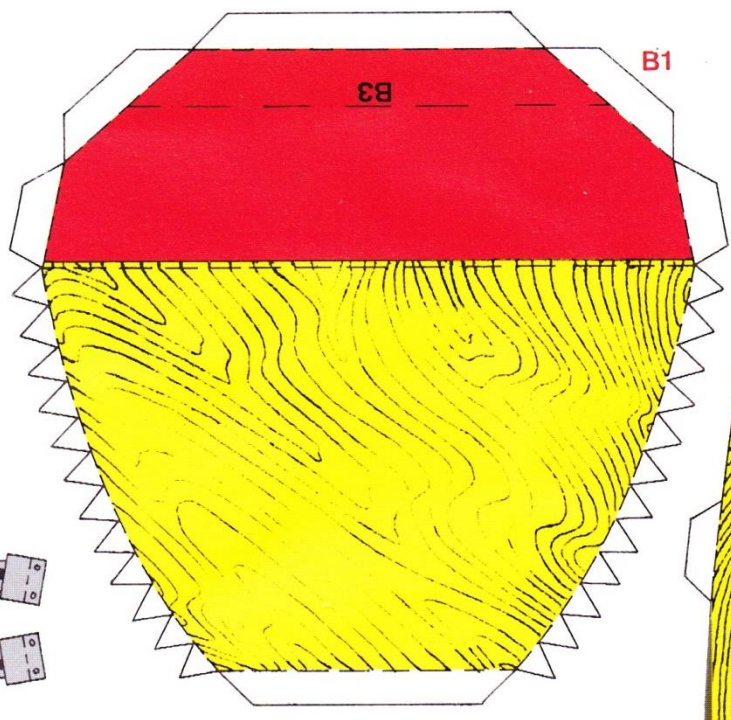

B1

B3

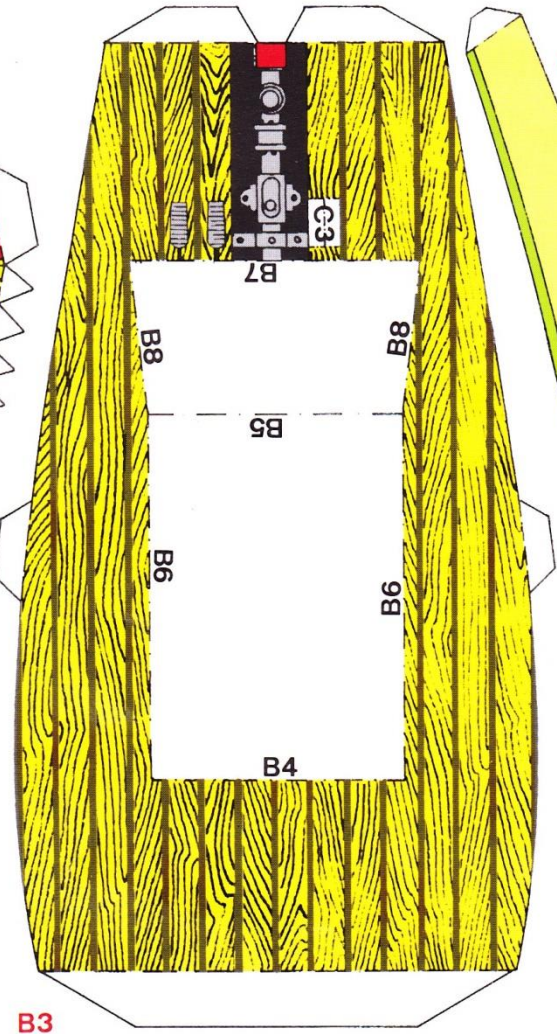

B3

C3

B7

B8

B8

B5

B6

B6

B4

A7

KAMELEON

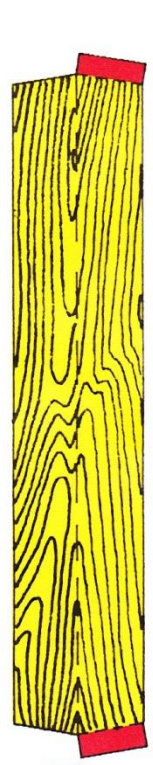

C4

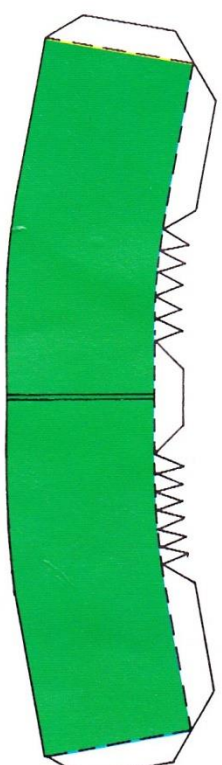

B8

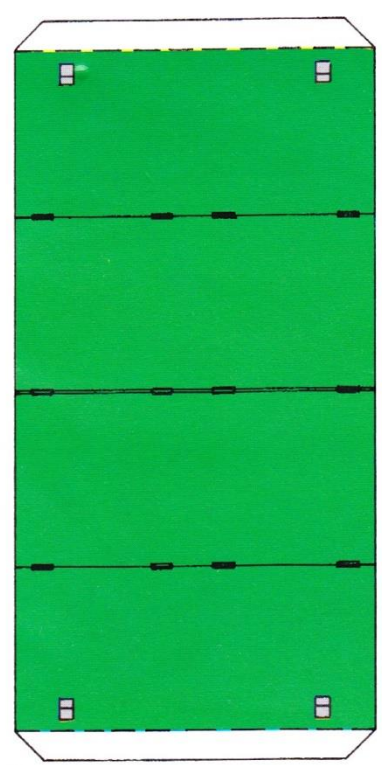

B6

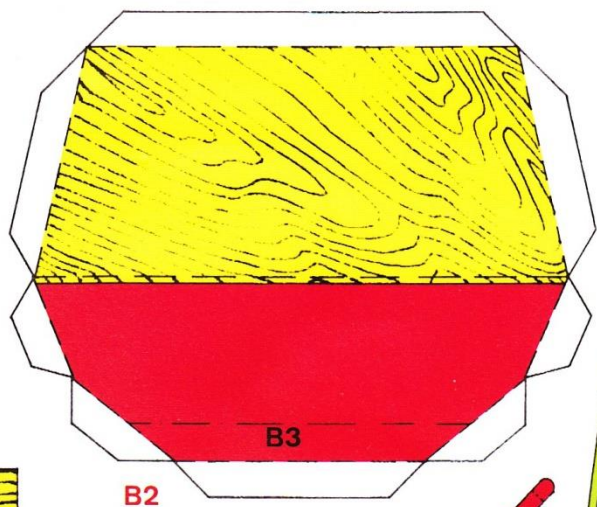

B2

B3

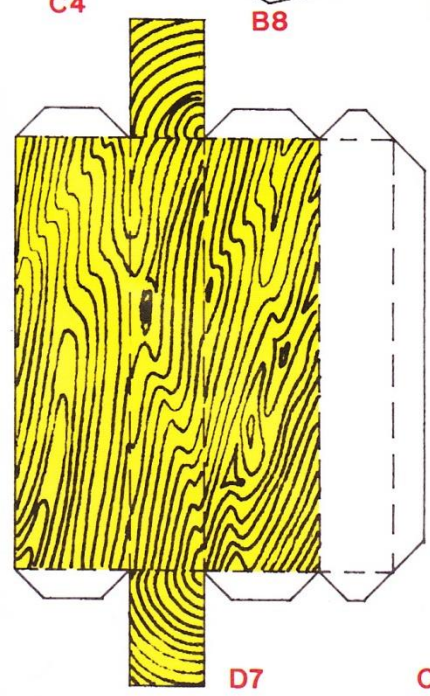

D7

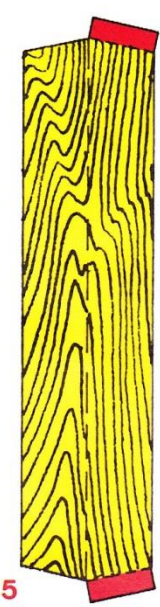

C5

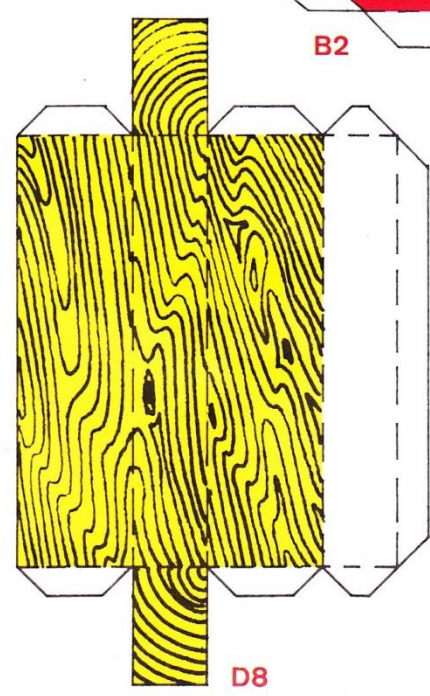

D8

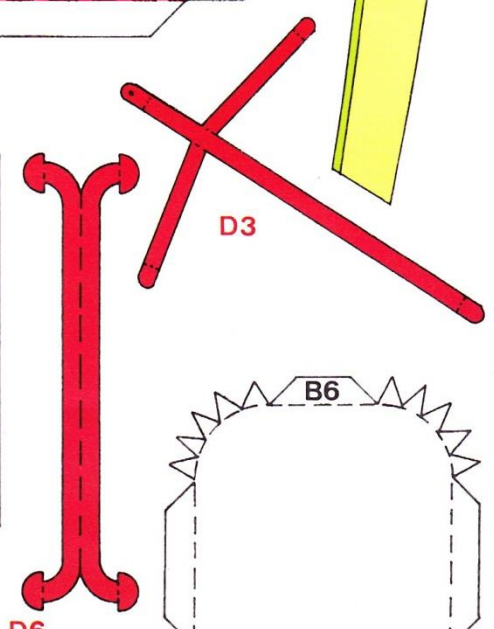

D3

D6

B5

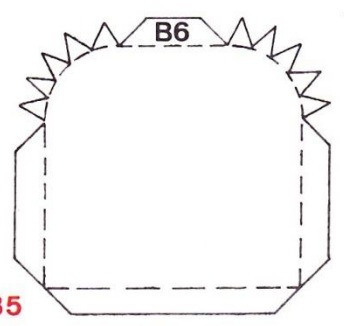

B6

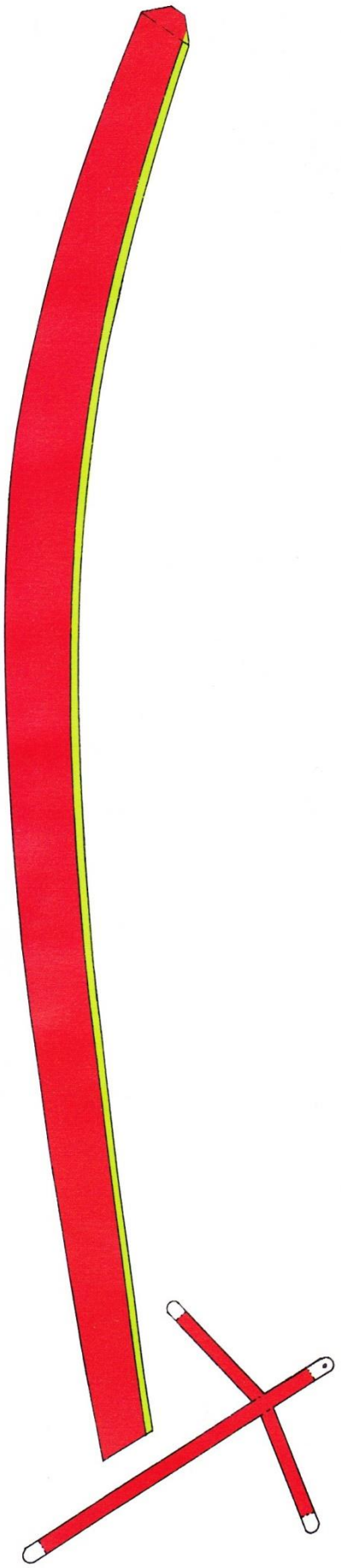

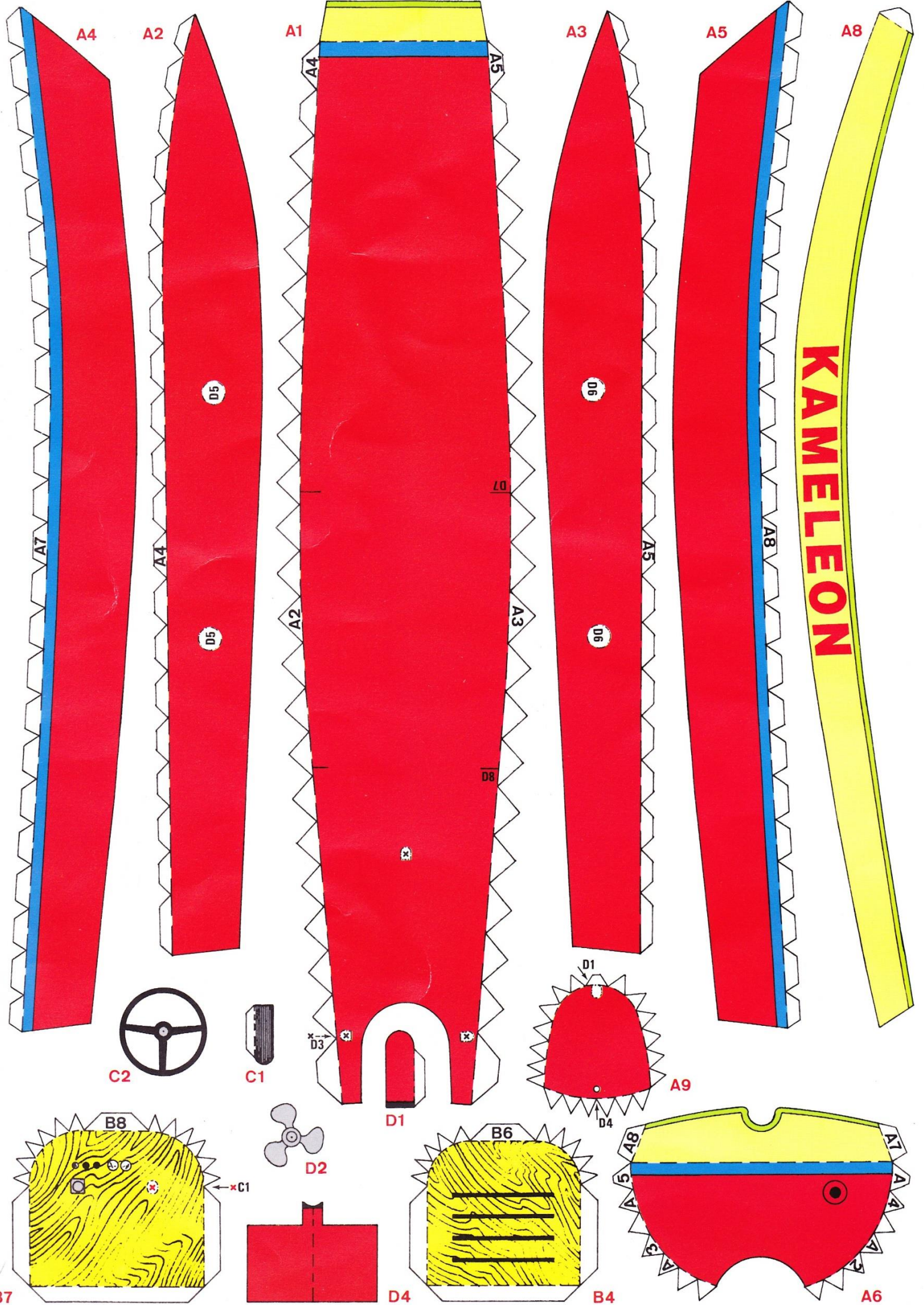

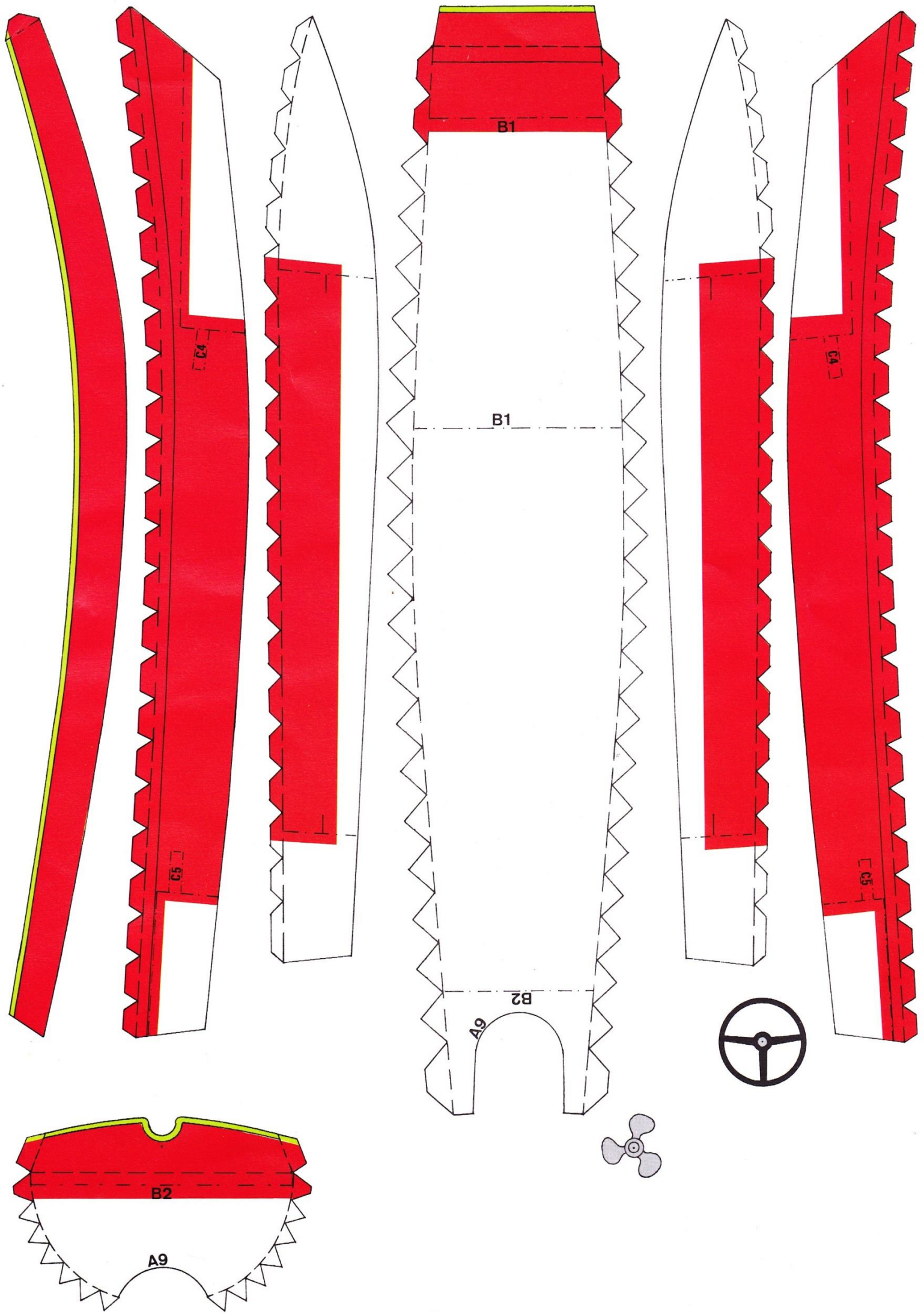

## Gebruiksaanwijzing:

De bovenstaande pagina's moeten dubbelzijdig uitgeprint worden. Het mooiste is om dit op een stevig papiersoort te doen. Dit werkt prettiger met het maken van het bouwpakket, maar hij wordt ook steviger, waardoor hij niet zo snel stuk gaat.

De onderdelen zijn genummerd. Op de plakrandjes staat welk nummer eraan geplakt moet worden. Dit spreekt dus voor zich.

Dit betreft een bouwpakket, welke gedownload is van de website van de schippers van de kameleon.